

Operation Manual for

M210 Time System

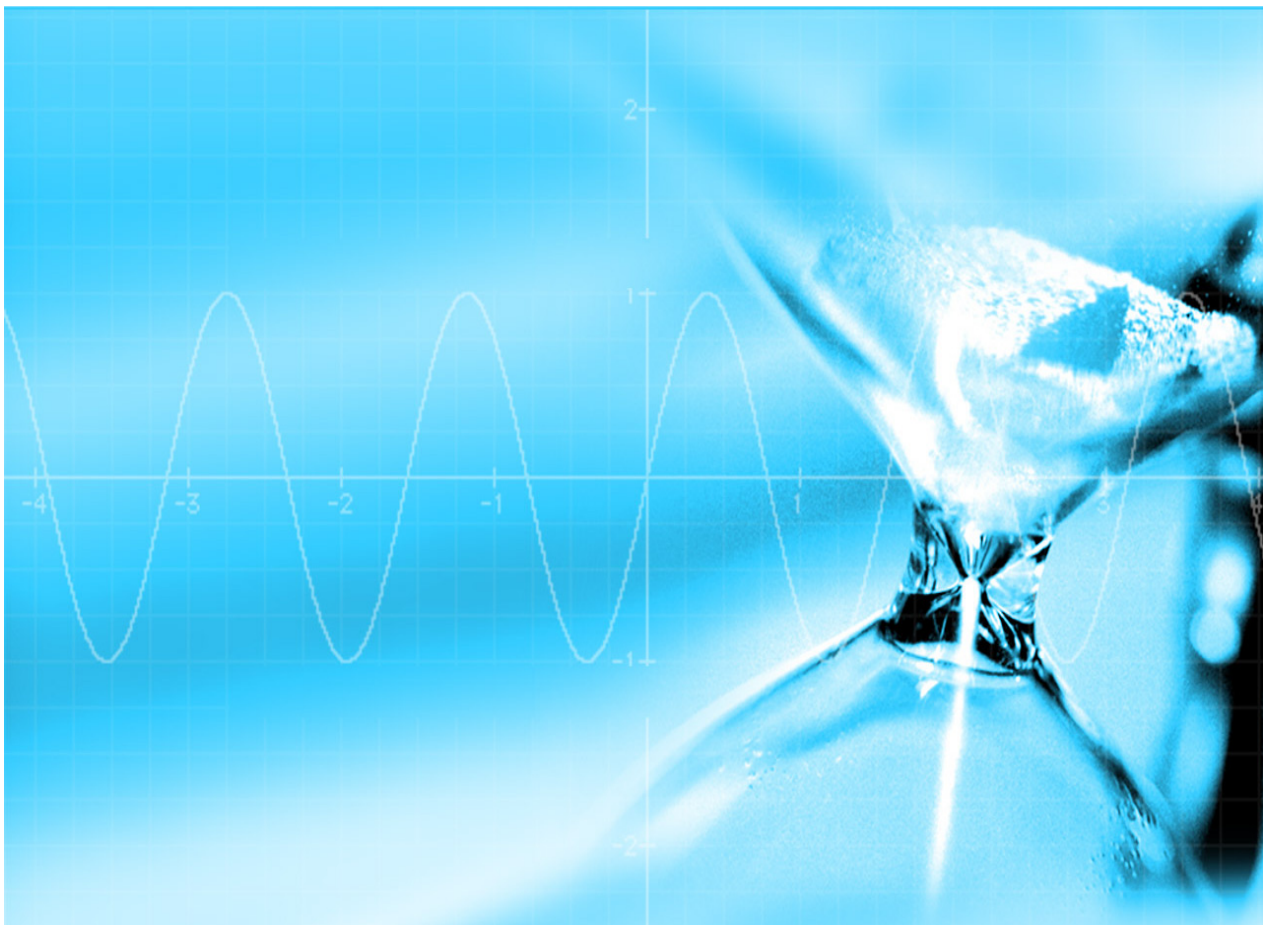

0210EY049N

Issue 2

Time & Frequency Solutions Ltd©2007

This page is intentionally left blank.

Preface

Purpose

This manual has been written as a guide for the operation of Time & Frequency Solutions Ltd's M210 Time System.

Audience

This manual is intended for use by engineers & operators responsible for the operation of this equipment.

Revision History

Revision History

Issue	Date	Revision History
1	09 Nov 2006	Ammended from 0210EY049J Iss 3 (S Eavery)
2	29 Aug 2007	Added to DST switch menu (S Eavery)

Warnings & Cautions

Warnings

Dangerous voltages exist in this equipment. Do not attempt any repair without first switching off power to the system, at the front panel switch, and removing the power input connector.

Nickel, cadmium and lithium are toxic substances. A nickel cadmium battery or lithium battery is dangerous if broken or dismantled. If any battery chemicals come into contact with skin, wash with copious amount of water, and seek medical attention as required. If the battery is swallowed seek immediate medical attention. Return any faulty batteries to the manufacturer, properly packaged, for disposal.

The liquid crystal display can be hazardous if broken or dismantled. If any liquid crystal chemicals come into contact with skin, wash with soap and water. Return the faulty display to the factory, for disposal.

Most board assemblies contain tantalum capacitors or electrolytic capacitors. Both types can explode under fault conditions. Take appropriate precautions when servicing the unit with the lid removed.

Cautions

This unit should only be serviced by qualified personnel, no user serviceable parts inside.

Several Board Assemblies contain static sensitive devices. Appropriate procedures must be used when handling these items.

Care must be taken in physically handling the system. When lifting the system, appropriate lifting procedures must be followed that appropriate to the weight of the unit.

Limited Warranty Information

Hardware and Embedded Software

For a period of one (1) year from date of shipment by Time and Frequency Solutions Ltd. (TFS), TFS warrants that all Products shall be free from defects in design, material, and workmanship; shall conform to and perform in accordance with TFS's published specification, if any; and shall have good and valid title. This warranty will survive inspection, acceptance, and payment by the Buyer. TFS does not warrant that the operation of such Products will be uninterrupted or error free. This warranty does not cover failures caused by acts of God, electrical or environmental conditions; abuse, negligence, accident, loss or damage in transit; or improper site preparation.

This warranty shall be null and void in the event (i) Buyer or any third party attempts repair of the goods without TFS's advance written authorization; (ii) defects are the result of improper or inadequate maintenance by Buyer or third party; (iii) of damage to said goods by Buyer or third party-supplied software, interfacing or supplies; (iv) of improper use (including termination of non-certified third party equipment on TFS's proprietary interfaces and operation outside of the product's specifications) by the Buyer or third party; or (v) the goods are shipped to any country other than that originally specified in the Buyer's purchase order.

Goods not meeting the foregoing warranty will be repaired or replaced, at TFS's option, upon return to TFS's factory freight prepaid; provided, however, that the Buyer has first obtained authorization from TFS.

TFS reserves the right to disallow a warranty claim following an inspection of returned product. When a warranty claim is questioned or disallowed, TFS will contact the Buyer by telephone or in writing to resolve the problem.

Software

TFS warrants that for a period of ninety (90) days from date of shipment by TFS the accompanying media will be free from defects in materials and workmanship under normal use. The physical media warranty does not apply to defects arising from misuse, theft, vandalism, fire, water, acts of God, or other similar perils. TFS will not be liable for any damages caused by the Buyer's failure to fulfil its responsibilities as stated above.

Limitation of Liability

The remedies provided herein are the Buyer's sole and exclusive remedies. In no event or circumstances will TFS be liable to the Buyer for indirect, special, incidental or consequential damages, including without limitation, loss of revenues or profits, business interruption costs, loss of data or software restoration, or damages relating to the Buyer's procurement of substitute products or services. Except for liability for personal injury or property damage arising from TFS's negligence or wilful misconduct, in no event will TFS's total cumulative liability in connection with any order of TFS's Goods, from all causes of action of any kind, including tort, contract, negligence, strict liability, and breach of warranty, exceed the total amount paid by the Buyer. Some Jurisdictions do not allow certain limitations or exclusions of liability, so the above limitations or exclusions may not apply to all buyers.

The foregoing warranty is in lieu of all other warranties, expressed or implied, including, but not limited to, any implied warranties of title, merchantability, or fitness for a particular purpose howsoever arising.

Contents

Chapter 1: Introduction to the M210 Time System	1
Chapter 2: M210 Time System Installation	7
Chapter 3: Initialisation of the M210 Time System	9
Chapter 4: M210 Time System Operation	11
Chapter 5: Maintenance & Fault Finding	27

This page is intentionally left blank.

Chapter 1:

Introduction to the M210 Time System

Product Overview

The M210 Time System from Time & Frequency Solutions Ltd is designed for use in applications where reliable time information is required; such as time display, systems synchronisation or scientific experimentation.

The M210 Time System provides a Master Clock based upon an internal central microprocessor. This microprocessor provides timekeeping functions and has an alphanumeric display with keypad for control, configuration and reporting of the unit.

The design of the M210 Time System allows inclusion of up to 3 options from a large range of modules within a 1U rack format. This gives the M210 Time System the ability to synchronise to various national and international time standards, output time and date in various formats, and perform auxiliary tasks.

The timing oscillator within the M210 Time System is specified, at time of order, to provide the required precision for the particular application.

Technical Specification

Technical Specification of the M210 Time System

Item	Specification
Display	24 * 2 row backlit LCD 5 mm character height
Keypad	5 button keypad for equipment configuration and control
Weight	7 Kg (dependant on options fitted)
Mechanical Depth	305mm
Mechanical Height	1U (IEC 60297)
Mounting Requirements	19" Standard Rack (IEC 60297)
Available Option Modules	3
Power Requirements	See reference manual for PSU Module
Temperature Operation	0°C to +40°C
Humidity	Up to 95% RH (non-condensing)
EMC	CE Compliant

M210 Time System Architecture

The M210 Time System is designed to accept up to 3 option modules. The option slots are numbered 1 to 3, and when viewed from the rear, correspond from 1 (left hand side) to 3 (right hand side). The system architecture is shown below.

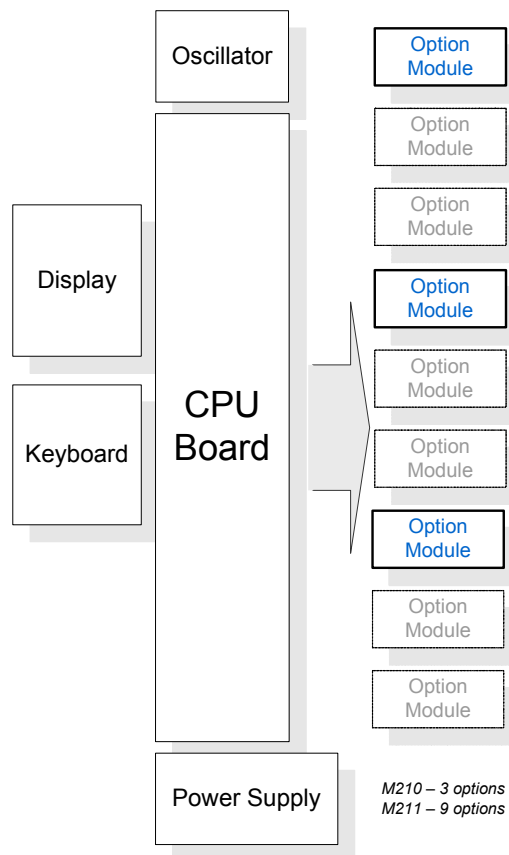

Synchronising Source

The M210 Time System can be used with or without Time Receiver options.

No Source

When the M210 Time System is not fitted with a Time Receiver module, the unit will act as a 24 hour clock. When a time has been entered through the user menu it will also run a calendar function with leap year correction. The unit's accuracy will depend on the oscillator fitted and the time elapsed since time and date were entered.

With Time Source

When used in conjunction with a Time Receiver option, the M210 Time System provides enhanced time performance by continuously receiving, decoding and synchronising to received time signals.

Oscillator Disciplining

The M210 Time System if fitted and configured for a suitable oscillator contains a disciplining section.

The disciplining section compares a pulse per second generated from the M210 Time System oscillator with a reference pulse per second from the Receiver Module being used for synchronisation.

By comparison and analysis of the time (phase) differences between the two pulses over a longer period, a disciplining algorithm can then control the oscillator frequency. This controlled oscillator will give a superior synchronisation performance and also allows for better clock accuracy in holdover periods, should the Time sources become invalid.

Most receiver modules are able to provide a reference pulse to the M210 Time System. However, those such as the Real Time Clock, some RF and Timecode Modules are not able to do so.

Time Zones, Daylight Savings and Local Time

The M210 Time System runs a 24 hour clock from power on. When it acquires time through either a Time Receiver Module or manual time entry, it runs both a Local Time and UTC Time buffer. The Local Time buffer's offset from UTC is determined from the Time Zone offset and Daylight Savings Time (DST) menus.

Time Zone The 'Time Zone' offset menu defines the base offset from UTC of the Local Time buffer. This should be set as required.

DST Feature This feature, if present and enabled, automatically implements the Daylight Savings hour which is added during Summer Time in some regions.

Front Panel Display and Data Outputs The M210 Time System display can be configured to show either the Local or UTC Time. Unless otherwise selectable or stated otherwise, data outputs from option modules will be Local Time.

Note The Daylight Savings menu may not be enabled in every M210 Time System, and some off-air time sources have their own DST signalling. Where the DST menu is present, any receiver module's DST signalling will be overridden.

Leap Seconds

On occasion a second is added or taken from UTC in order to bring it back towards the observed astronomical time. This is necessary since the definition of atomic time is slightly faster than the average observed solar time. It is also found that large geological events can jolt the normal rotation of the earth.

The times of the leap seconds are announced by BIPM in France (www.bipm.fr), and generally occur at the end of June or December. For example on the insertion of a leap second the time will advance as follows:

31/12/05 23:59:58

31/12/05 23:59:59

31/12/05 23:59:60

01/01/06 00:00:00

01/01/06 00:00:01

Some time sources, such as GPS, signal a pending leap second - whereas others do not. In the case of MSF an imminent leap second can be derived from a disrupted normal progress of the timecode through the minute leading up to the leap second.

Because there is uncertainty as to whether the M210 Time System will receive and handle a pending leap second event a menu item is included to manually force this event.

Chapter 2:

M210 Time System Installation

Installation

Three methods are available for mounting the M210 Time System into a standard 19" Rack.

Shelves

The M210 Time System may be mounted on shelves located within the 19" Rack.

Slides

The M210 Time System can optionally be supplied with slides, which are easily fitted to the side of the chassis. The slides are installed into the 19" rack allowing the M210 Time System to glide easily in and out.

Mounting Ears

The M210 Time System is supplied with mounting ears to allow its retention in a standard 19" rack. Each mounting ear accepts two screws. Cage nuts are fitted to the rack at the appropriate position for retention of the screws.

Connection to the M210 Time System

Power Supply Please refer to the appropriate M210 Time System Power Supply Manual for further information on connection of the external power source.

Option Module Connections Please refer to the appropriate M210 Time System Option Module Manual for further information on connection to each of the option modules.

Voltage Selection

Before **any** external power source is connected to the M210 Time System, confirm that the supply voltage is suitable for its use. Labelling on the rear panel of the M210 Time System indicates the specified input voltage(s).

Warning Use of an incorrect supply voltage with the M210 Time System may result in damage to the equipment and may cause a fire risk. Equipment that has been damaged through incorrect supply voltage(s) is expressly excluded from Time & Frequency Solutions Ltd's equipment warranty.

Chapter 3:

Initialisation of the M210 Time System

Powering on the M210 Time System

A mains power switch is provided on the M210 Time System and is located on the right hand side of the front panel. The switch is marked **POWER**.

Position **I** turns the M210 Time System **on**

Position **O** turns the M210 Time System **off**

Initialisation

After the M210 Time System has been powered on, the equipment will go through a brief initialisation period and display a start-up message containing the software part number and version number.

Error Checking The Central CPU Software has Built-In Test Equipment procedures incorporated within. These procedures routinely test the functionality of the Central CPU, its associated hardware, and any option boards that are fitted.

When the M210 Time System is switched on, the RAM and ROM for the central CPU are initially tested, followed by tests of any option cards that are fitted to the unit. If all the tests are completed satisfactorily, the M210 Time System will function normally. If an error is detected the front panel will display **** SELF TEST FAILED ****.

Elapsed Time After initialisation, the display will change to indicate elapsed time since power on.

Status Indicators

The M210 Time System provides two illuminated LED indicators; **ON** and **STATUS**.

ON indicator The **ON** indicator provides an indication of the Power Supply status. If not illuminated either no power is applied or there is a Power Supply fault. If illuminated then Power is present. The illumination colour depends on the Power Supply fitted. Refer to the Power Supply Manual for more information.

STATUS indicator The **STATUS** indicator provides an indication of the M210 Time System's CPU watchdog status. An illuminated LED indicates no fault. If the LED is flashing or not illuminated, the CPU is faulty.

Display Contrast

The visibility of the front panel display may be adjusted to optimise its contrast and viewing angle.

Adjustment is made to a trimmer using a small flat blade screwdriver. The trimmer is accessed through a small hole located on the right-hand side panel of the M210 Time System, approximately 50mm from the front panel.

Chapter 4:

M210 Time System Operation

Equipment Operation

For ease of understanding, an Operation Manual is available for each Option Module. Accordingly, for information on operation of modules please refer to their appropriate manual. This section refers only to the operation of the M210 Time System.

Keyboard Operation

Configuration and operation of the M210 Time System is accessed by use of a 5-button keypad located on the front panel. This allows access and control of the M210 Time System through the menu structure.

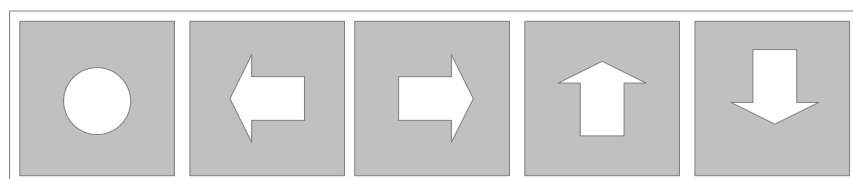

Enter

Left

Right

Up

Down

Display Operation

The M210 Time System is provided with a 2-row by 24-character alphanumeric display. In normal operation, when the user menus are not being accessed, the top row of the display indicates date and time, together with general status information.

The lower row of the display is used to display status information specific to a particular option module slot. As a typical example, the M210 Time System may display the following information:

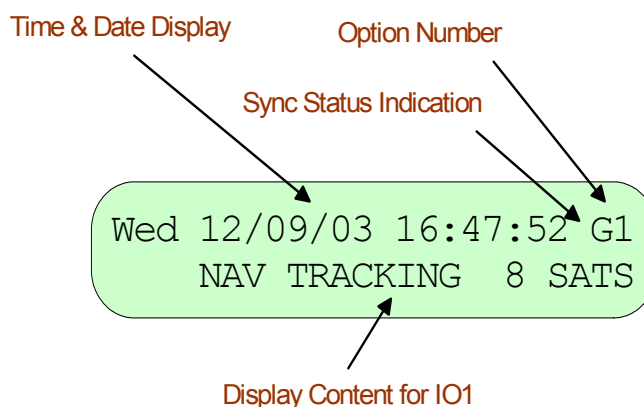

Time & Date Display

The time and date are shown on the top line.

Option Number

The number '1' on the top row indicates that the lower row is displaying the status of the Option Module in IO1 (Option slot 1), in this case a GPS Receiver Module.

***Sync Status
Indication***

The top second most right character, here '*G*', indicates the synchronisation status of the M210 Time System. A lower case letter shows where the M210 Time System *intends* to obtain time from. An upper case letter shows from which source the *M210 Time System* is currently obtaining time. The letter assignment is as follows:

d/D - DCF (Germany)

g/G - GPS

h/H - Havequick

n/N - NTP Peer to Peer

o/O - Octal Module, serial input

m/M - MSF (UK)

r/R - Real Time Clock Module

t/T - IRIG / Timecode

w/W - WWVB (US)

A space indicates that no Time Receiver Module can be found within the M210 Time System.

Menu Operation

The user menus are accessed by pressing the ENTER key when the normal Time and Date display is shown. Full details of the user menus are shown in the Menu Structure Section of this manual. A menu navigation guide is shown below.

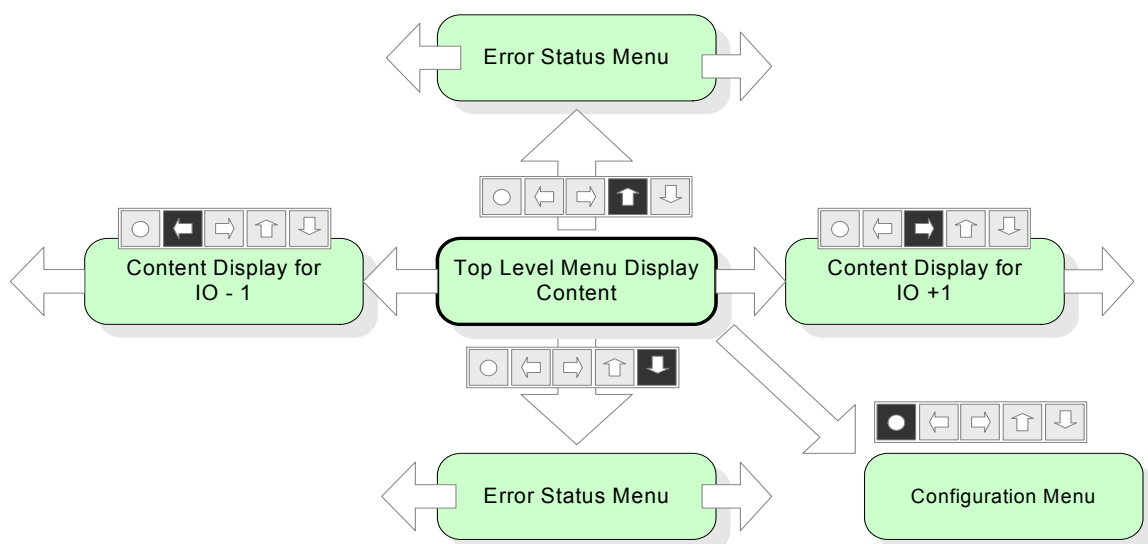

Error Status Menu

Pressing an UP or DOWN key when the normal Time and Date display is shown (without pressing ENTER) will allow the user to access the error status menus.

Display Content

Pressing the LEFT or RIGHT key when the normal Time and Date display is shown, accesses the Display Content for an option module.

Pressing the RIGHT key increments the option slot number displayed, whilst pressing the LEFT key decrements the option slot number.

This selection of Display Content is not retained in non-volatile memory. The Display Content shown from power on is that configured by the Configuration Menu >> Equipment >> Display Content menu.

Parameter Selection

When selection of a parameter is available, the LEFT or RIGHT keys are used to position the cursor under the required parameter on the display. Pressing ENTER will accept the selection made and returns back one level up the menu tree.

Data Entry

When data entry is available, the LEFT or RIGHT keys are used to position the cursor under the number/character to be entered. Use of the UP or DOWN keys then allows the data to be amended. Pressing the UP key increments the number/character, whilst pressing the DOWN key decrements the number/character.

When a series of numbers/characters are to be entered for a particular function, each number/character is entered by moving the cursor onto each number/character in turn and incrementing/decrementing as appropriate. Pressing ENTER accepts the data and returns back one level up the menu tree.

Notes

The majority of the configuration parameters are stored in non-volatile memory, so they remain on power-down. Only the entry of Time and Date are not stored in this way.

The M210 Time System will return to the normal Time and Date display 30 seconds after the last key press. Menus are available after the initial start-up message clears following switch on.

CPU Status Display

The CPU Status display is indicated by a '0' in the top right hand side of the display. The CPU Status Display provides information regarding the synchronisation status of the Time System, the local time zone, DST and Leap Second status.

The CPU Status display content may show the following information.

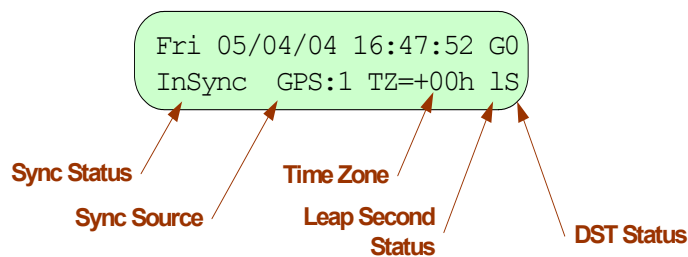

Sync Status

Time & Date are shown, as normal, in the top row of the display.

In the bottom row, the left hand data block indicates one of the following:

NoTime: The M210 Time System has never synchronised.

Manual: The M210 Time System is using manually entered time and date.

InSync: the M210 Time System is currently synchronising.

NoSync: the M210 Time System has previously synchronised but is not currently synchronised.

The M210 Time System continually attempts to synchronise to the selected time source and there may be brief periods when it does not synchronise. During these brief periods, the M210 Time System will still have valid time with stability dependent on the specification of the oscillator fitted.

Sync Source Following *Sync Status* is text describing the most recent source of synchronisation (rather than the system's intended source). The number following is the IO position of that time source.

Time Zone Following the Sync Source indicator is the Time Zone indicator. If the CONFIGURATION >> INITIALISATION >> TIME DISPLAY menu setting is *LOCAL* then this will show the Time Zone offset setting in hours '*TZ=±xxhrs*'. Note that the Time and Date displayed on the first line may have an additional hour added because of Daylight Savings. If the CONFIGURATION>>INITIALISATION>> TIME DISPLAY menu *UTC* then it just shows '*UTC Time*'.

DST Status If the DST feature is available and enabled, and the CONFIGURATION >> INITIALISATION >> TIME DISPLAY menu setting is *LOCAL*, either '*W*' or '*S*' is shown for Winter or Summer Time. During Summer Time the M210 Time System applies an additional hour.

Leap Second Status When the M210 Time System has its leap second warning set a '*l*' is shown. In the minute leading up to the leap second this changes to '*L*', indicating that the current minute will have 61 seconds. Leap Seconds are only inserted at the end of June or December. The Leap Second status can be ammended in the CONFIGURATION >> INITIALISATION >> LEAP SECOND SETUP menu. Note that if a Receiver Option receives a leap second warning, this will overwrite any setting made through the menu.

The leap second setting is stored in permanent memory, therefore a received warning is remembered. This does mean that such warnings may need to be subsequently cleared if the unit was not in operation during the leap second event.

Disciplining Status Page

This display is indicated by a 'D' at the far right of the top line display. It provides status of the disciplining section. If

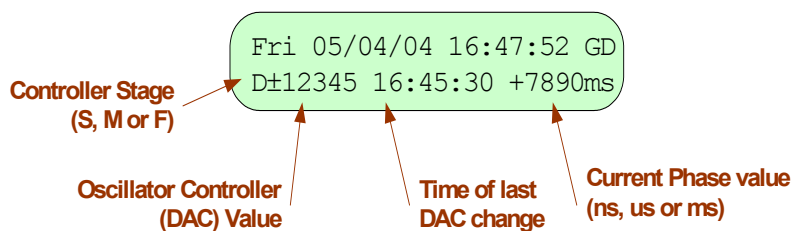

the disciplining section is not providing its status to the CPU then the data will not be filled in.

Controller Stage

The disciplining algorithm has various stages in the controlling of the oscillator. The letters S(slow), M(medium), F(fast) refer to how aggressive the oscillator control slope is. After an extended time, depending on the oscillator type and the quality of the reference pulse, the Controller Stage will move from F, to M, to S.

DAC value

This shows the current value of the Oscillator Controller.

Time of Last DAC change

This shows the last local time at which the DAC was changed. As the algorithm proceeds from Fast to Slow the DAC should be changed less often. In the case of a Rubidium Oscillator this may show 'Rb Cold' when oscillator adjustment would be premature, or may show 'Rb Fail' when the oscillator frequency can not be further corrected.

Menu Structure

The following diagram shows the menu structure for the M210 Time System.

The menu items are accessed by pressing the ENTER key when the normal Time and Date Display is shown. Pressing the ENTER key will display the Configuration Menu. At the Configuration Menu, the LEFT and RIGHT keys can be used to select the required menu.

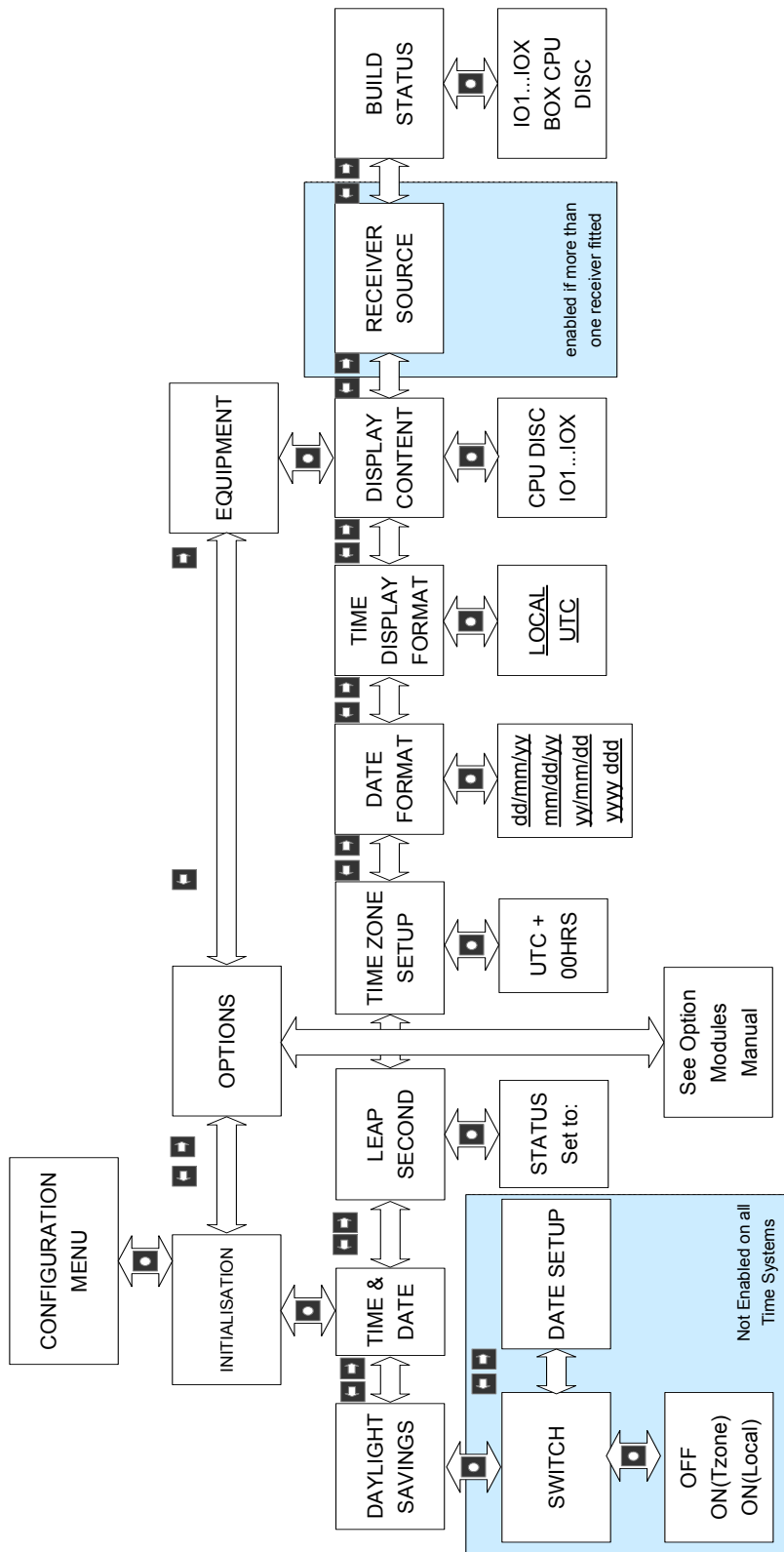

Configuration Menu >> Initialisation

Time & Date

This menu is used for manual entry of time and date. Manual entry of time and date can only be completed when the equipment has not synchronised through a Receiver Module.

Data is entered via three screens: one for date entry, one for day of week entry, and the third for time entry. The LEFT and RIGHT keys move the cursor to each number/character in each screen, whilst the UP and DOWN keys are used to amend the data.

ENTER moves forward through each of the three screens. An invalid entry causes an error message, with the cursor moving to the invalid data.

Note: the date has to be entered in the same format as set in Date Format (see CONFIGURATION MENU >> EQUIPMENT >> DATE FORMAT).

Selection of ABORT, or moving through the screens without making any data entry results in the original time being retained.

Successful entry of time and date causes the left-hand side of the lower row of the CPU Status display to show 'Manual', indicating manually entered time.

Leap Second Status

This menu is used to display and set the Leap Second warning status.

On entry to the menu the top line shows the current status of the Leap Second, either as 'NONE' or 'WARN'.

The second line allows the warning to be cleared or set, or to leave the menu without change.

Daylight Savings

Please note that this feature may not be enabled on some models of the M210 Time System and therefore this configuration setup will not be present within the menu.

This menu allows the setup of the Daylight Savings feature. Daylight Savings Time (DST) is used in a number of high latitude countries throughout the world for optimisation of daylight periods in summer and winter.

Upon entry to the Daylight Savings menu, two selections are possible.

First is the DST Switch menu. This menu has three selections. The **OFF** selection means that the DST algorithm is not used, therefore the clock remains at the same UTC offset all year. The **ON(TZone)** selection means that DST is applied between the days and times setup in the Date Setup menu. The hour that the changeover happens on is the Time Zone (i.e uncorrected) time. For example if the hour is set to 02:00 then summer happens as 01:59:59W goes to 03:00:00S and winter happens 02:59:59S goes to 02:00:00W. The **ON(Local)** selection works as the ON(TZone) selection, except that the hour of changeover happens at the Local (i.e corrected) time. For example if the hour is set to 02:00 then summer happens as 01:59:59W goes to 03:00:00S and winter happens 01:59:59S goes to 01:00:00W.

Second is the Date Setup menu. Here the dates of the DST changes can also be pre-programmed for a number of years. This ensures that the DST changes will be implemented at exactly the correct instant. Upon entering the Date Setup Menu, the following information is displayed:

```
DST SETUP FOR 20xx  EXIT
On dd/mm Off dd/mm hh:00
```

The top row of the display specifies the year for which the dates are applicable. By using the UP/DOWN and LEFT/RIGHT keys, the cursor can be placed under the least significant digit of years. The UP and DOWN key can then be used to select the required year.

The lower row of the display specifies the DST changes for the year selected. The left hand date specifies the date at which DST becomes active, the right hand date specifies the date at which DST becomes inactive and the time on the right hand side specifies the time (local time) at which the change to DST is implemented.

For Northern Hemisphere DST times, the on time will precede the off time. For Southern Hemisphere DST times the off time will precede the on time

The LEFT and RIGHT keys are used to move the cursor to each number on the lower line of the display, and the UP and DOWN keys are used to set the required number. By entry of year, dates for DST changes, and the local time of the DST change, the DST changes can be preprogrammed for many years ahead.

Time Zone Setup

This menu sets up the basic Time Zone offset from UTC for the Local Time buffer. Valid Time Zone Offsets are -12 to +12 hours from UTC, in one hour steps. The LEFT or RIGHT keys are used to position the cursor under each digit, and the UP and DOWN keys are used to respectively increment or decrement that particular digit or to change the +/- sign of the offset. Once the desired number has been configured, ENTER is pressed to confirm the selection.

Configuration Menu >> Equipment

Date Format

This allows the setting of the date format for the front panel display. Four options are available:

- dd/mm/yy
- mm/dd/yy
- yy/mm/dd
- yyyy_ddd

This function does not alter the date format of any other data output from the Time System.

Time Format This allows the setting of the time format for the top row of the front panel display. Two options available are:

- UTC (Universal Co-ordinated Time)
- Local Time

Display Content This defines the default Display Content setting upon Power On. Selection is made between IO1 to IO3, CPU (CPU Status display) and DISC (disciplining circuit).

Receiver Source *This menu item is available when the M210 Time System has more than one time receiver option fitted.*

This menu defines which Time Receiver source will be used for time synchronisation by the M210 Time System. The choice displayed under this menu will depend on the receiver source modules fitted.

Build Status This menu allows examination of the build status of each option module fitted to the M210 Time System including the CPU board, and the chassis. The available selections are *IO1 to IO9, BOX (equipment chassis), CPU and DISC (disciplining section)*.

For the Option Modules, the build status provides firmware reference number, item serial number, edition (version) and date of manufacture.

For the CPU, the build status provides item serial number, edition (version) and date of manufacture. A further press of the ENTER key results in firmware identity and version together with CPU speed being displayed. A final press of the ENTER key results in the Timing Interrupt Source being displayed. This is normally set to *PREC*.

For the BOX (equipment chassis), the build status provides item serial number, Configuration Control Index (CCI) and date of manufacture.

For DISC the build status provides the disciplining firmware version and the oscillator reference number.

These menu are primarily intended to obtain service information whilst the M210 Time System remains in use.

Configuration Menu >> Option Setup

Under this menu the configuration and setup for each option module can be achieved.

By entering this menu a list of option numbers from 1 to 3 are displayed on the screen. Using the LEFT and RIGHT keys, the cursor can be positioned under the appropriate option module that requires configuration.

Please refer to the appropriate option module manual for more information on the menu structure for each option.

Chapter 5:

Maintenance & Fault Finding

Maintenance

Due to the highly reliable design of the M210 Time System, it is not a normal necessity to perform any maintenance on the unit. The M210 Time System includes comprehensive self-test capability which provides equipment diagnosis. The results of the diagnostic process are provided through the Error Status Menu.

Using the Error Status Menu

Error Status Menu

The Error Status Menu reports all BITE errors, which are viewable through the front panel.

Pressing either an UP or a DOWN key when the normal Time and Date display is shown (without pressing ENTER) will allow the user to access the Error Status Menu.

The following diagram explains the relationship of the key entry whilst the Normal Status System Display is shown.

Note

When the "Error Status Menu" is displayed, the display will return to the normal Time and Date Display after 30 seconds from the last key press.

Error Status Menu Display

If any Errors exist within the system they will be displayed in the 'Error Status Menu'. The LEFT and RIGHT keys are used to scroll between each error code present. (Use of the UP, DOWN, and ENTER keys returns the display to the normal Time and Date display).

The 'Error Status Menu' provides details of each particular error:



```
IOx.y: [Module Name]:aaaa  
[Error description text]
```

'x' defines the Option slot of the module that is reporting the error displayed on the screen.

'y' defines the Error code as a number (0 - 7).

'[Module Name]' is the name of the module that is reporting the error displayed on the screen.

'*aaa*' defines the type and level of error being displayed as follows:

INFO - Provides an indication of a system status change that has been detected. This type of error indicates the status and does not constitute a problem to the overall function of the M210 Time System.

WARN - Provides the user of a warning error that may constitute a problem to the M210 Time System.

FAIL - Provides the highest level of Failure. This type of error may indicate a failure of a Line Replaceable Unit within the M210 Time System, which may result in an operational problem with it.

Error Codes

The following table describes the error codes for the M210 Time System Chassis (CPU).

M210 Time System Error Codes

Error Number	Error Level	Failure Name	Description of Fault
0	FAIL	RAM Test Fail	Failure of CPU board
1	FAIL	ROM Test Fail	Failure of CPU board
6	FAIL	Timing Interrupt Fail	Failure of CPU board
7	WARN	System Not Synchronised	The timing system is presently not synchronised to a time source.

Any of the *FAIL'S* indicated above could be caused as a result of a faulty CPU board or option module.

Firmware Upgrades

Occasionally Time & Frequency Solutions Ltd may release new software to upgrade the reliability and function of the M210 Time System. If firmware has been supplied then please follow the steps outlined below.

Firmware Upgrade Procedure

1. Before starting any work on the timing system ensure that there is adequate access to the rear and the top of the unit.
- 2. Ensure that the unit is powered off and has its power supply lead removed.**
3. Whilst handling devices take adequate anti-static precautions.
4. Take off the lid of the timing unit by removing the 8 screws on the sides and rear of the lid. If necessary unbolt the earthing connections that have been made to the lid.
5. The CPU board is that which is immediately visible facing the top of the unit and is marked "0210FL000". The PROM's which contain the unit's software, are found in sockets IC27 and IC28. Remember the orientation of the PROMS.
6. Using a suitable extraction tool extract the existing PROM's
7. Place the new PROM with part number ending in 'E' into IC27 and the new PROM with part number ending in 'O' into IC28. Ensure that they are correctly orientated. Also ensure that all the pins are in the socket and are pushed home firmly.
8. Replace the Earth fixing to the Lid if it has been removed.
9. Replace the Lid and the 6 screws on the sides of the lid.

Note

It will not be necessary to re-enter any of the configuration information.

Customer Support

UK & International

After Sales Support Department

25 Eastways
Witham
Essex
CM8 3AL
United Kingdom
Tel. +44 (0) 1376 514114
Fax +44 (0) 1376 516116
support@timefreq.com

www.timefreq.com

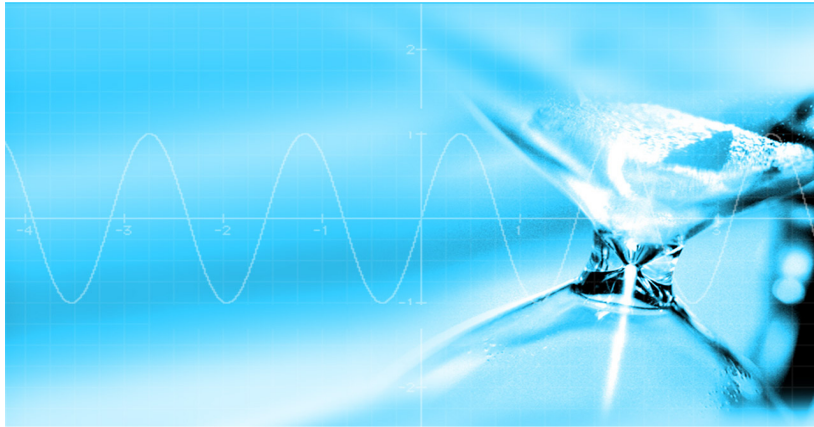

© Time & Frequency Solutions Ltd 2007